I_{Q_Charge} On MAX and MIN

--	--	--	--	--	--

(1)
(2)

--	--	--	--	--

$V_{(ANODE)}$				
$V_{(ANODE\ POR)}$	VANODE POR Rising threshold VANODE POR Falling threshold			
I_{SHDN}		$V_{EN} = 0V$		
$I_{Q_Charge\ Off}$				
$I_{Q_Charge\ On}$				

ENABLE

V_{EN_H}	Enable input high threshold			
V_{EN_L}	Enable input low threshold			
V_{EN_HYS}	Enable Hysteresis			



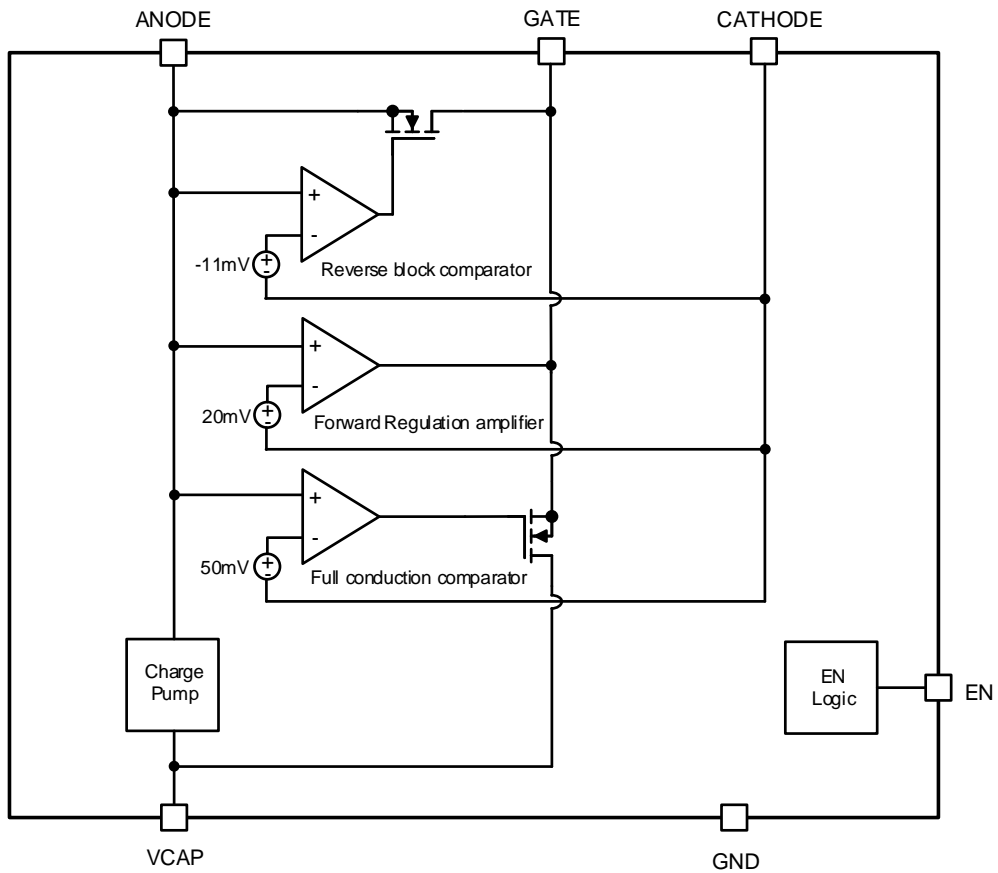

Overview

protection circuit or be used in a . This easy to use ideal diode controller operates in polarity conjunction with an external N-channel MOSFET to replace other reverse polarity schemes such as a P-channel MOSFET or a Schottky diode.

Input Voltage

Enable

Charge Pump

Gate Driver and Conduction Mode



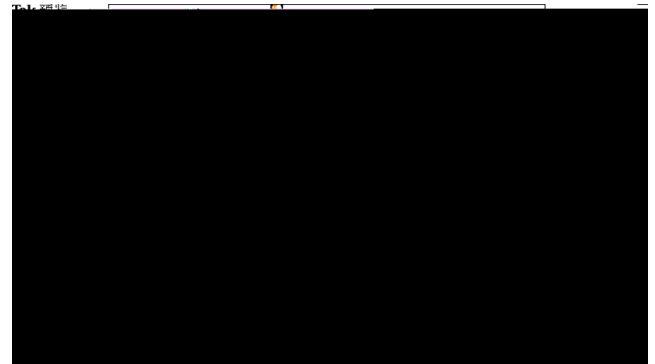
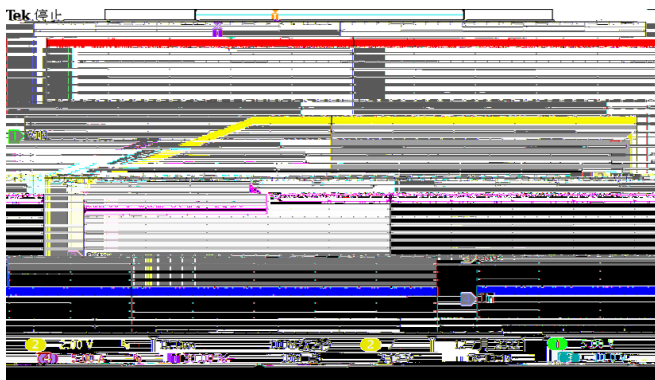
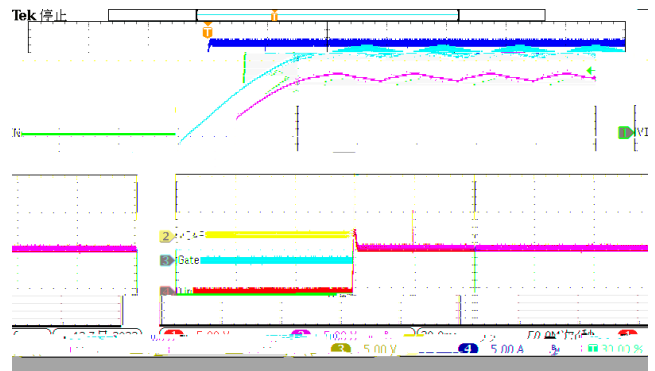
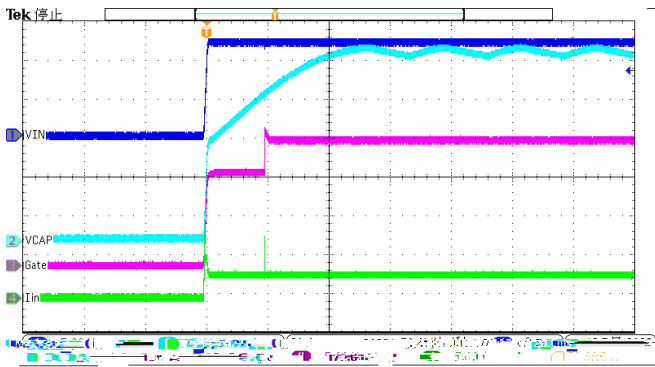
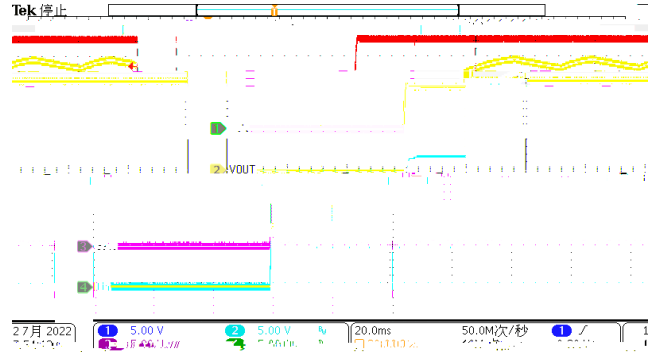
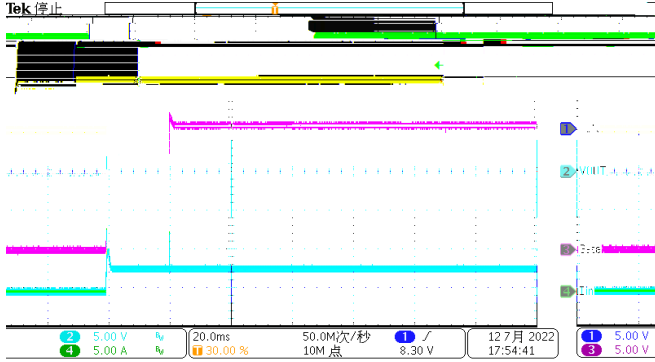

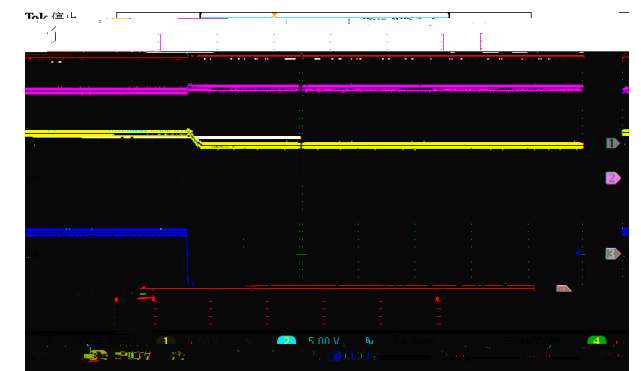
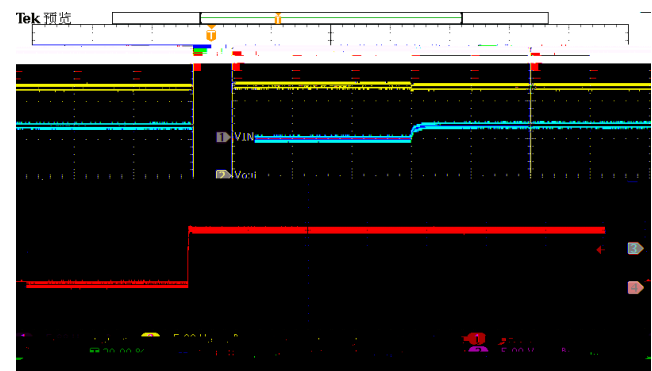
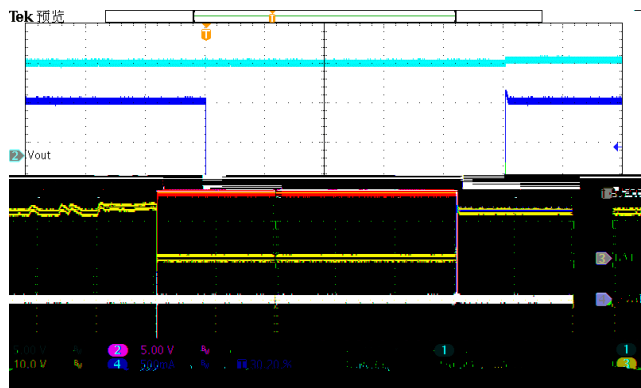
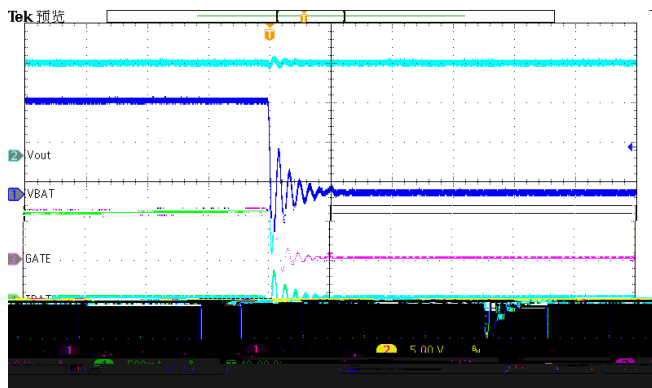
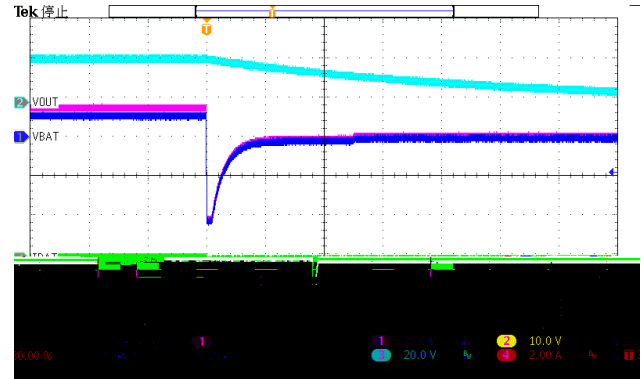
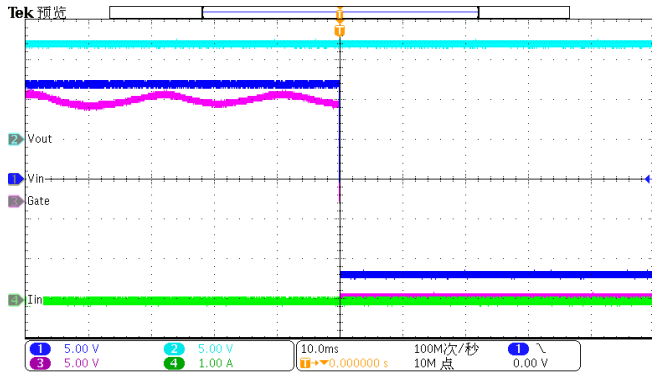

Typical Application- Redundant Power

