





G

G

G

|

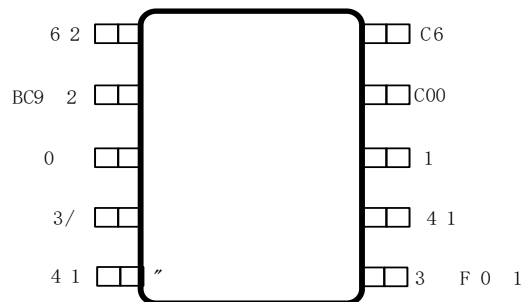

G

en-US



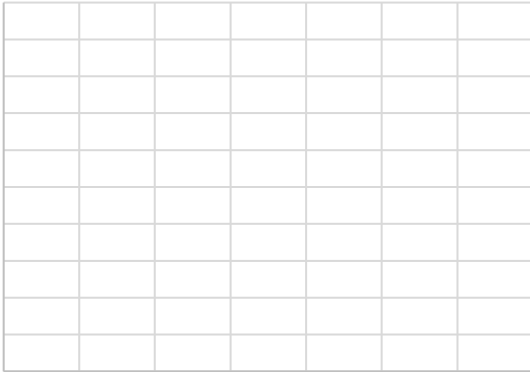
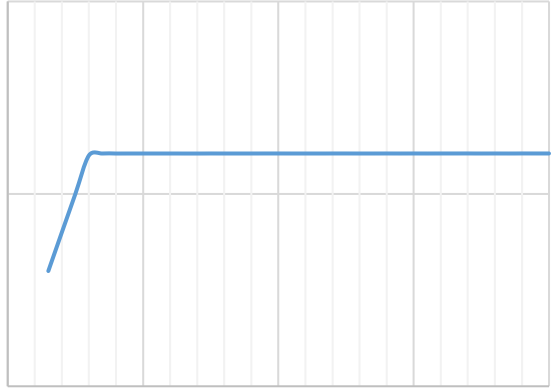
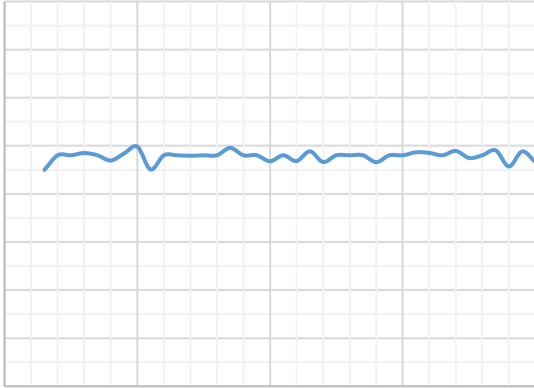

G

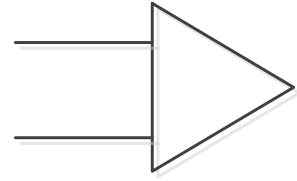
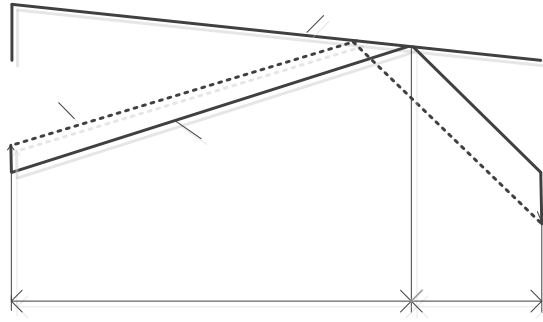

=

=

- = -

=

=

=

=

-

$$\Delta = - \frac{-}{+} \Delta$$

$$\Delta = - \frac{-}{-} \Delta$$

$$\left| - \frac{-}{+} \right|$$



$$= \frac{-}{\quad} \times$$

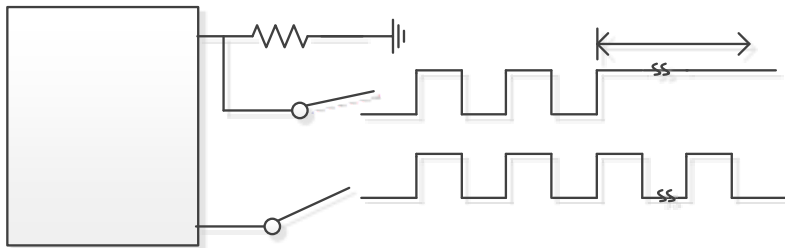
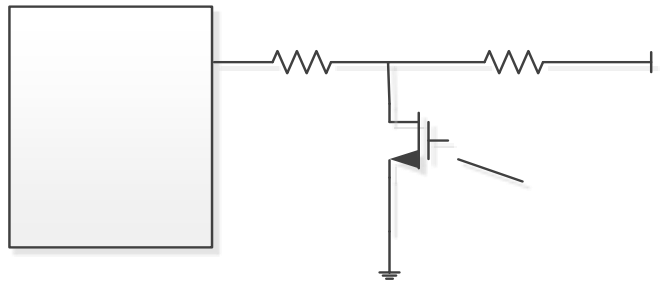

= _____

= _____

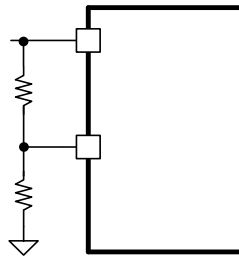

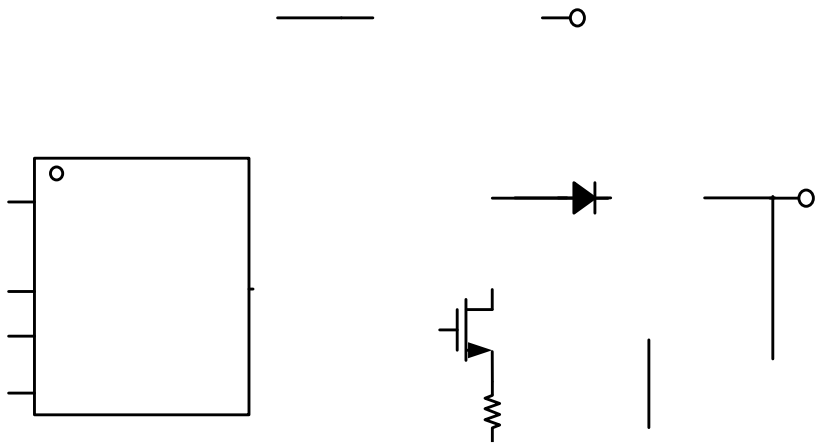





-
-
-



-





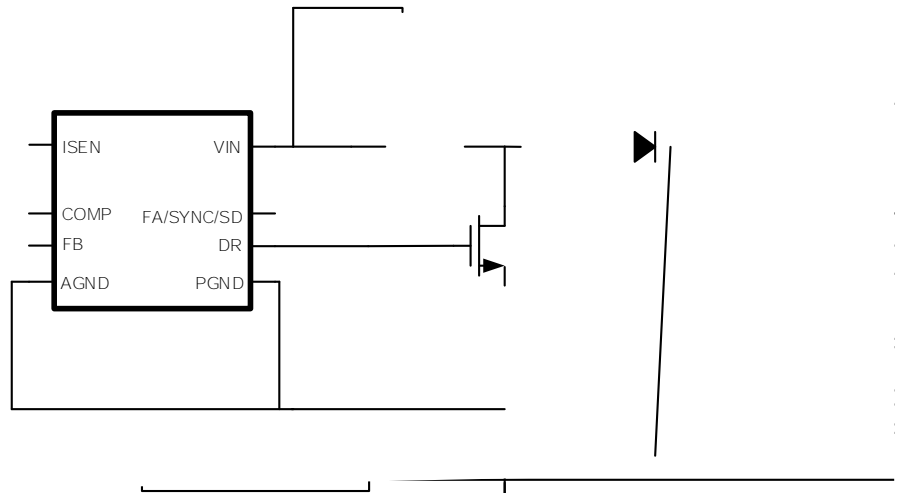

$$\Delta = x \quad x \text{---} x$$

$$= = \frac{\quad}{\Delta \quad x} x$$

$$= + \frac{\Delta}{\quad} = x \text{---} x + \text{---}$$

$$= + \frac{\Delta}{\quad} = x + \text{---}$$

$$= = - \frac{\quad}{x \Delta \quad x} x$$

